

COLONIAL INSTRUMENTS, INC. LASER ETCHED STAINLESS STEEL TAGS

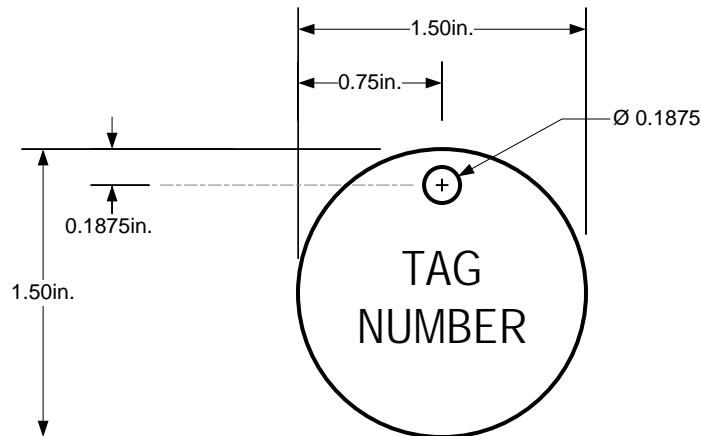

STANDARD FEATURES

Material:	316 Stainless Steel
Tag Size:	1.50" Diameter Round x 0.048"
Tag Color:	Matte Finish
Text:	Black Laser Etched
Standard Text Size:	3/8" Arial Narrow Font
3/8" Characters:	Up to 7 Per Line, Max. 1 Line
1/4" Characters:	Up to 10 Per Line, Max. 2 Lines
3/16" Characters:	Up to 13 Per Line, Max. 3 Lines
Corner:	N/A
Hole:	3/16" Centered at Top

TAG SPECIFICATION

Colonial Instruments P/N: S6BLE-150R-18-H13-MF, Black Laser Etched Heavy Duty Tag, 316 Stainless Steel, 1.50" Round" x 0.048" (18 Gauge), (1) 3/16" Diameter Hole Centered at Top, Matte Finish, with 12" x 0.020" Stainless Steel Soft Temper Attachment Wire



COLONIAL INSTRUMENTS, inc.
 ONE CHESTNUT STREET, NASHUA, NH 03060
 P: (800) 442-8437 • F: (603) 882-7878 • SALES@COLONIALGAUGES.COM

DATE: 09-19-2019

DRAWN BY: JARROD WILLIAMS

COLONIAL PART NUMBER: S6BLE-150R-18-H13-MF